



G12-N20 Geared Mini DC Motor

This is a DC Mini Metal Gear Motor, ideal for making robots. Light weight, high torque and various RPM. Fine craftsmanship, durable, not easy to wear. With excellent stall characteristics, can climb hills easily. You can also easily mount a wheel on the motor's output shaft. Widely used on boat, model car, robotic, home appliances and linear motion control.



SKU: [EMH1176](#)

Brief Data:

- Model: GA12-N20.
- Medium Power MP: 0.5W Max.
- Rated Voltage: 6~12V.
- Revolving Speed: Refer to Table 1.
- Torque: Refer to Table 1.
- Rated Current: 0.04A.
- Stall Current: 0.67A.
- Total Length: 34mm.
- Gear Material: Full Metal.
- Gearbox Size: 15 x 12 x 10mm (LxWxH).
- Shaft Size: Ø3 x 10mm (D*L). D-Type Shaft.
- Net Weight: 10g.

Stalling this gear motor could cause gear damage!

Mechanical Dimension:

Unit: mm

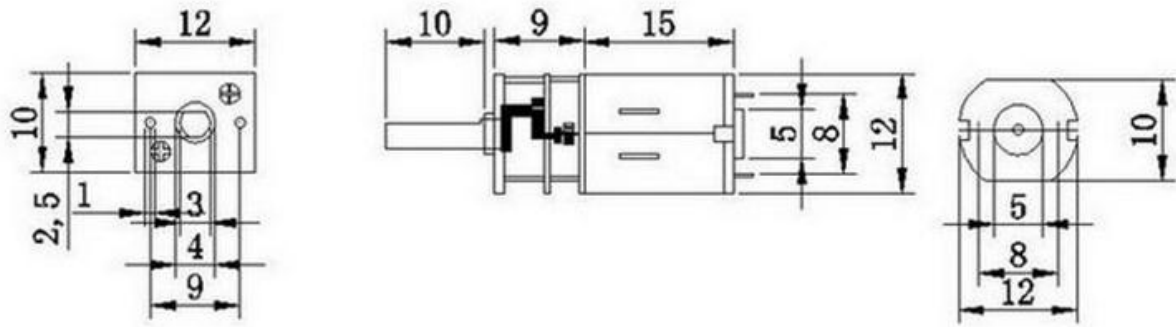

Size (Unit: mm)

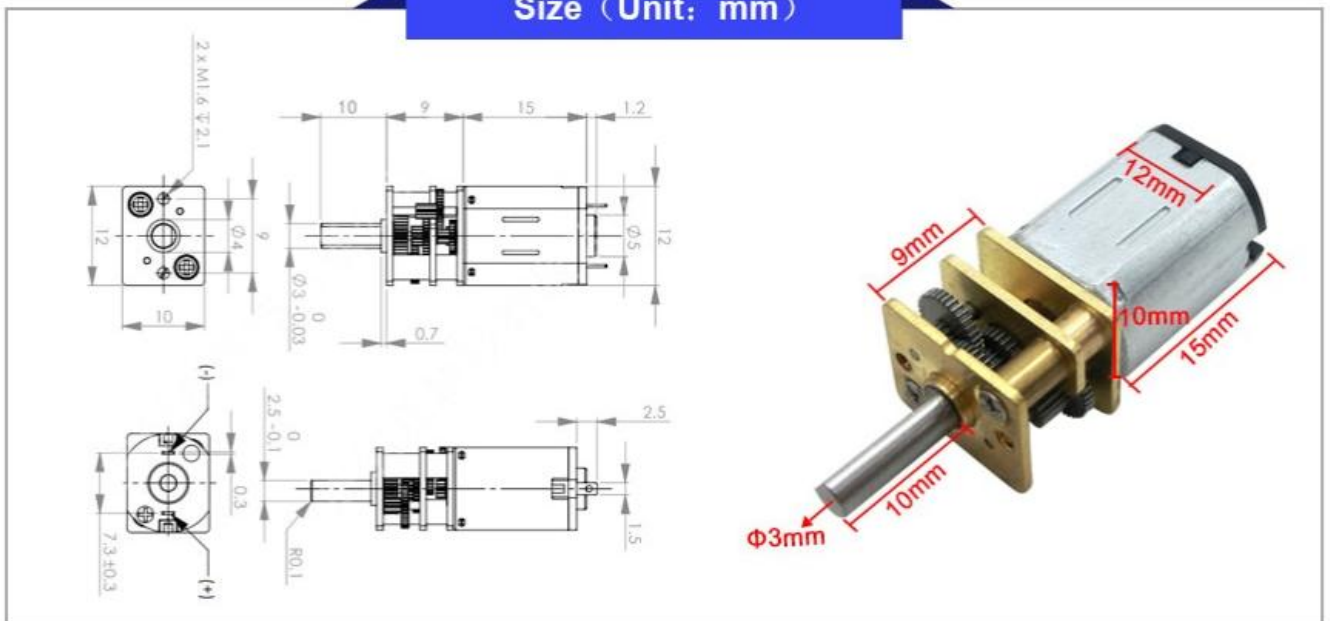

Table-1:

Model	No Load Speed RPM	Torque Max Kg.mm	Stalled Torque Kg.mm	SKU
GA12-N20-100	6V@100 12V@200	3.4	17	EMH1176
GA12-N20-200	6V@200 12V@400	1.9	9.4	EMH1189
GA12-N20-450	6V@450 12V@900	1.2	5.4	EMH1190

Application Examples:



Related Products:

- [42mm Rubber Wheels](#)
- [GA12-N20 Motor Mounting Bracket](#)
- [68mm High Grip Rubber Wheel for Robotics Car](#)

Application Note: Useful Motor/Torque Equations

Force (Newtons)

$$F = m \times a$$

m = mass (kg)

a = acceleration (m/s²)

Motor Torque (Newton-meters)

$$T = F \times d$$

F = force (Newtons)

d = moment arm (meters)

Power (Watts)

$$P = I \times V$$

I = current (amps)

V = voltage (volts)

$$P = T \times \omega$$

T = torque (Newton-meters)

ω = angular velocity (radian/second)

Unit Conversions

Length (1 in = 0.0254 m)

Velocity (1 RPM = 0.105 rad/sec)

Torque (1 in-lb = 0.112985 N-m)

Power (1 HP = 745.7 W)

Example 1

Determine if the following motor can be used to lift a 5-kg load using a 0.5-m lever arm.

Merkle-Korff Gearmotor specifications

Stall Torque = 40 in-lb

Stall Current = 3.5 amps

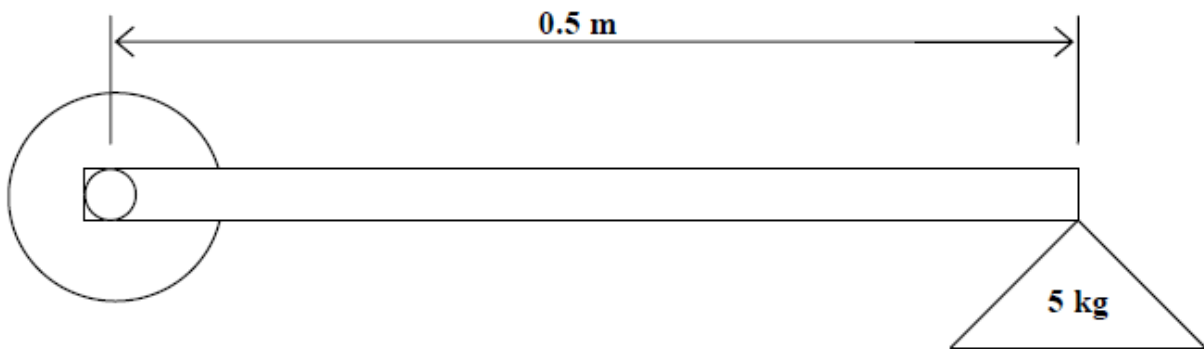

Solution

Convert Stall Torque from in-lb to N-m

$$1 \text{ in-lb} = 0.112985 \text{ N-m}$$

$$40 \text{ in-lb} = 40 \times 0.112985 \text{ N-m} = 4.5194 \text{ N-m}$$

Calculate the Force required to lift the 5-kg load

$$F = m \times a = 5 \text{ kg} \times 9.81 \text{ m/s}^2 = 49.05 \text{ N}$$

Calculate the Torque required to lift the Force with the lever arm

$$T = F \times d = 49.05 \text{ N} \times 0.5 \text{ m} = 24.525 \text{ N-m}$$

We cannot perform the lift with this set-up, because the stall torque is smaller than the torque required for the lift. We must either shorten the length of the lever arm, or we must choose another motor with a higher stall torque to perform this operation.

Example 2

Using the same motor as in Example 1 with a 12-V power supply:

- a) Calculate the power used by the motor to rotate a 5-kg load at 50 RPM using a 3-inch lever arm.
- b) Calculate the current draw from the battery to perform this operation.

Solution

Convert inches to meters:

$$1 \text{ in} = 0.0254 \text{ m}$$

$$3 \text{ in} = 0.0762 \text{ m}$$

Calculate the Force required to lift the 5-kg load:

$$F = m \times a = 5 \text{ kg} \times 9.81 \text{ m/s}^2 = 49.05 \text{ N}$$

Calculate the Torque required for this operation:

$$T = F \times d = 49.05 \text{ N} \times 0.0762 \text{ m} = 3.738 \text{ N-m}$$

Note- This torque is lower than the motor's stall torque, so this operation is possible using the specified motor, mass, and lever arm

Convert RPM to radians/second:

$$1 \text{ RPM} \times 2\pi \text{ rad/rev} \times 1 \text{ min}/60 \text{ sec} = 0.105 \text{ rad/sec}$$

$$\omega = 50 \text{ rev/min} \times 0.105 \text{ rad/sec/RPM} = 5.25 \text{ rad/sec}$$

Calculate the Power required for this operation:

$$P = T \times \omega = 3.738 \text{ N-m} \times 5.25 \text{ rad/sec} = 19.622 \text{ W}$$

Calculate the Current draw from the battery (use the supply voltage in this calculation):

$$I = P/V = 19.622 \text{ W}/12 \text{ V} = 1.635 \text{ Amps}$$

Note- This current is smaller than the maximum allowable current draw of the motor.

Example 3

Determine the motor torque necessary to power the robot drive wheels.

Solution

The following approach is merely one way to solve this problem. Several exist.

Assume the robot will be powered by two powered drive wheels and supported by two freely rotating caster wheels. Robot weight is denoted by W and for this simple example we'll assume the weight is distributed evenly over all 4 wheels, as shown in Figure 1 below.

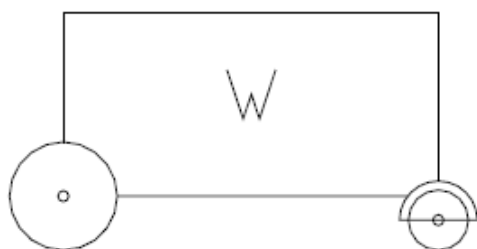

Figure 1

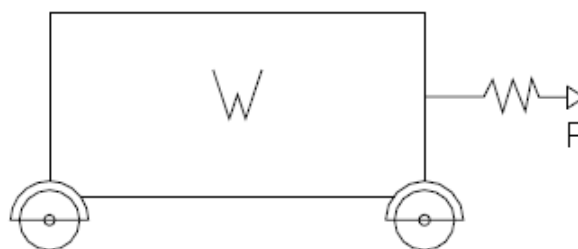

Figure 2

Thinking logically about the problem, we could model the robot as having 4 of the identical caster wheels (Figure 2) and the force required to propel the robot is simply the force needed to start the robot moving (this could be measured empirically with a force scale). The problem is we haven't yet built the robot so testing it in this manner is not an option. We need to calculate the force (and hence motor torque) required to move the robot **before** we build anything.

Looking closer at the caster wheel we can see the actual friction that must be overcome to put the robot in motion. F_w is the friction force between the wheel and the floor and F_a is the friction force between the wheel and the axle. T_w and T_a are the respective torques between the wheel and floor and the wheel and axle.

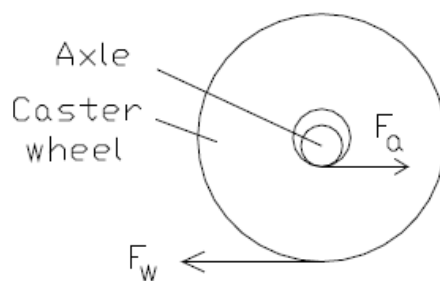

Figure 3

$$F_a = W/2 * \mu_a$$

$$T_a = F_a * R_a$$

$$F_w = W/2 * \mu_w$$

$$T_w = F_w * R_w$$

T_w is the *maximum* torque the wheel can transmit to the ground before it slips.

Our goal is to find a realistic range for T_m , the motor torque.

As calculated above, T_w would be the *maximum* amount of torque the motor could transfer to the ground before the wheel begins to slip (ie T_m , max).

Typically, we desire $\mu_w > \mu_a$, so the wheel does not slip/slide across the floor, but rather rolls. We can easily look up the μ_a value for the axle/wheel materials in contact. Knowing μ_a and the weight of the vehicle, F_a can be computed. This is the *minimum* amount of force we would have to provide at the wheel/axle interface to overcome the friction between the two. To relate the computed axle force F_a to the *minimum* amount of

wheel torque required to move the robot, we would use the “virtual radius” of the wheel/axle combination, which is computed as follows:

$$R_v = R_w - R_a$$

This is the fictitious radius about which F_a would act to rotate the wheel about the tangent point in contact with the ground at any instant, as shown in Figure 4 below.

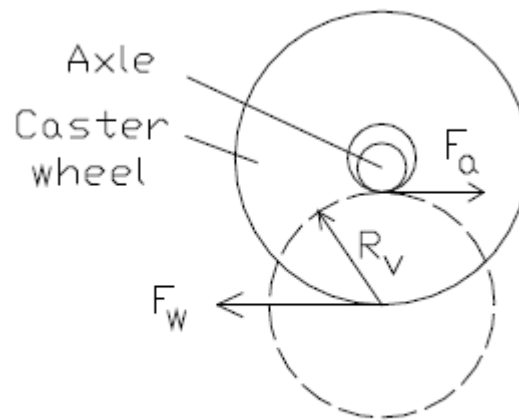

Figure 4

Therefore our equation for the *minimum* amount of torque the motor must transfer to the ground before the wheel begins to roll (thus causing the robot to move) would be:

$$T_m (\min) = F_a * R_v = F_a * (R_w - R_a)$$

In summation, $T_m, \min \leq T_m \leq T_m, \max$ or alternatively, $F_a * (R_w - R_a) \leq T_m \leq F_w * R_w$

Motors, Fans and Accessories Selection

40x40x10 mm DC Brushless Cooling Fan

Ultra quiet powerful brushless DC fan, quiet sleeve-bearing design. Specialized design, professional made, stable performance. Operating Temperature: -10 C to +60C. Long Life Expectancy.



EMH-1071 **GDT4010S12B** **RM 6.50**

GA12-N20 Geared Mini DC Motor

This is a DC Mini Metal Gear Motor, ideal for making robots. Light weight, high torque and low RPM. Fine craftsmanship, durable, not easy to wear. Widely used on boat, model car, robotic, home appliances, linear motion control.



EMH-1176 **GA12-N20** **RM 18.50**

30x30x10 mm DC Brushless Cooling Fan

Ultra quiet powerful brushless DC fan, quiet sleeve-bearing design. Specialized design, professional made, stable performance. Operating Temperature: -10 C to +60C. Long Life Expectancy.



EMH-1070 **GDT3010S12B** **RM 7.50**

Nema23 Bipolar/Unipolar Stepper Motor 1.0A

A stepper motor to satisfy all your 3D-Printer, robotics, Linear Motion projects needs! This 6-wire uni-polar/bipolar stepper motor has 1.8° per step for smooth motion and a nice holding torque.



EMH-1179 **23HS2610** **RM 110.00**

1.2A Nema 17 Stepper Motor

A stepper motor to satisfy all your 3D-Printer, robotics, Linear Motion projects needs! This 4-wire bipolar stepper has 1.8° per step for smooth motion and a nice holding torque.



EMH-1016 **42HS40-1204D** **RM 44.50**

1.7A Nema 17 Stepper Motor

A stepper motor to satisfy all your 3D-Printer, robotics, Linear Motion projects needs! This 4-wire bipolar stepper has 1.8° per step for smooth motion and a nice holding torque.



EMH-1181 **17HS-4401SD** **RM 47.00**

SG90 Tower Pro Gear Micro Servo Motor

Tiny and lightweight with high output power. Servo can rotate approximately 180 degrees (90 in each direction). Good for beginners who want to make stuff move without building a motor controller with feedback & gear box.



EMH-1140 **TPSG90S** **RM 7.40**

Nema-17 Planetary Geared Stepper Motor

This high precision NEMA17 Stepper motor has an integrated Planetary Gearbox with 1:5.18 gear ratio, the resolution can reach 0.35°step angle.



EMH-1173 **42BYGP40P** **RM 185.00**



Handsontec.com

We have the parts for your ideas

HandsOn Technology provides a multimedia and interactive platform for everyone interested in electronics. From beginner to diehard, from student to lecturer. Information, education, inspiration and entertainment. Analog and digital, practical and theoretical; software and hardware.



open source
hardware

HandsOn Technology support Open Source Hardware (OSHW) Development Platform.

Learn : Design : Share

www.handsontec.com



The Face behind our product quality...

In a world of constant change and continuous technological development, a new or replacement product is never far away – and they all need to be tested.

Many vendors simply import and sell without checks and this cannot be the ultimate interests of anyone, particularly the customer. Every part sell on Handsotec is fully tested. So when buying from Handsotec products range, you can be confident you're getting outstanding quality and value.

We keep adding the new parts so that you can get rolling on your next project.



www.handsontec.com

[Breakout Boards & Modules](#)



[Connectors](#)



www.handsontec.com

[Electro-Mechanical Parts](#)



www.handsontec.com

[Engineering Material](#)



www.handsontec.com

[Mechanical Hardware](#)



[Electronics Components](#)

P



www.handsontec.com

[Power Supply](#)



[Arduino Board & Shield](#)

[Tools & Accessory](#)



www.handsontec.com

[Tools & Accessory](#)